



EasyTouch® 8 and 4 Pool and Spa Control System (with optional IntelliChlor® Salt Chlorine Generator)



Installation Guide

IMPORTANT SAFETY INSTRUCTIONS
READ AND FOLLOW ALL INSTRUCTIONS
SAVE THESE INSTRUCTIONS



© 2008 Pentair Water Pool and Spa, Inc. All rights reserved.

1620 Hawkins Ave., Sanford, NC 27330 • (919) 566-8000

10951 West Los Angeles Ave., Moorpark, CA 93021 • (800) 553-5000

EasyTouch®, IntelliChlor®, QuickTouch® and Pentair Water Pool and Spa® are registered trademarks of Pentair Water Pool and Spa, Inc. and/or its affiliated companies in the United States and/or other countries. Unless noted, names and brands of others that may be used in this document are not used to indicate an affiliation or endorsement between the proprietors of these names and brands and Pentair Water Pool and Spa, Inc. Those names and brands may be the trademarks or registered trademarks of those parties or others.

P/N 520583 - Rev C - 10/01/2008

Contents

IMPORTANT SAFETY INSTRUCTIONS	ii
General Installation Information	iii
Technical Support	iv
EasyTouch 8 and 4 Pool and Spa Control System Kit Contents	1
EasyTouch Accessory Equipment.....	1
EasyTouch System Installation Steps Summary	2
Required Tools	2
Plumbing Requirements	3
Equipment Location	4
EasyTouch Load Center High Voltage Connections	6
EasyTouch Load Center Location	6
Preparing the EasyTouch Load Center	8
Mounting the EasyTouch Load Center	9
Removing Electrical Conduit Knockouts	10
Installing Conduit and Wire to the EasyTouch Load Center	11
EasyTouch Motherboard Connections	13
Accessing the EasyTouch Motherboard	14
Installing Auxiliary Relays	15
Installing Valve Actuators	16
Installing and Connecting Temperature Sensors	17
Water Temperature Sensor	17
Ambient Air Temperature (Freeze Protection) Sensor	17
Solar Temperature Sensor (Optional)	17
Connecting the Heater Thermostat	18
Connecting the IntelliChlor Cell	19
Rewiring the IntelliChlor Transformer for 115 VAC	20
EasyTouch System Start-Up	21
Verifying IntelliChlor Power	22
EasyTouch System Wiring Diagram	23
Glossary	24

IMPORTANT SAFETY PRECAUTIONS



Important Notice

This manual provides installation and operation instructions for the product. Consult Pentair Water with any questions regarding this product.

Attention Installer: This manual contains important information about the installation, operation and safe use of this product. Leave this manual with the owner and/or operator of this product after installation.

Attention User: This manual contains important information that will help you in operating and maintaining this product. Please retain it for future reference.

⚠ WARNING Before installing this product, read and follow all safety warning notices and instructions which are included. Failure to follow safety warnings and instructions can result in severe injury, death, or property damage. Call (800) 831-7133 for additional free copies of these instructions.

Read and Follow all Safety Instructions

This product is designed and manufactured for safe and reliable service when installed, operated and maintained according to the information and installation codes referred to in this manual.

⚠ This is a safety alert symbol. When you see this symbol in this manual or on the product, look for one of the following signal words; **DANGER, WARNING, CAUTION** and **NOTICE** and comply with the information. Be alert to the potential hazard. Ensure to read and comply with all of the warnings and cautions in this manual.

⚠ DANGER! Risk of Electrical Shock or Electrocution!

This product must be installed by a licensed electrician or qualified pool service persons. Installations must comply with:







- The National Electric Code (NEC) or Canadian Electrical Code (CEC).
- All applicable local codes and ordinances.
- Always disconnect power at the circuit breaker before servicing the load center. Failure to do so could result in death or serious injury to installer, service person, pool users, or others due to electrical shock.
- Improper installation can create an electrical shock hazard that can result in death or serious injury.



⚠ WARNING Water temperature in excess of 100 degrees Fahrenheit may be hazardous to your health. Prolonged immersion in hot water may induce hyperthermia. Hyperthermia occurs when the internal temperature of the body reaches a level several degrees above normal body temperature of 98.6° F (37° C). The symptoms of hyperthermia include drowsiness, lethargy, dizziness, fainting, and an increase in the internal temperature of the body.

- The effects of hyperthermia include:
- 1) Unawareness of impending danger.
 - 2) Failure to perceive heat.
 - 3) Failure to recognize the need to leave the spa.
 - 4) Physical inability to exit the spa.
 - 5) Fetal damage in pregnant women.
 - 6) Unconsciousness resulting in danger of drowning.

IMPORTANT SAFETY PRECAUTIONS (Continued)

-  **WARNING** To reduce the risk of injury, do not permit children to use this product unless they are closely supervised at all times.
-  **WARNING** The use of alcohol, drugs, or medication can greatly increase the risk of fatal hyperthermia in hot tubs and spas.
-  **WARNING** Control System is intended to control heaters with built-in high limit circuits **ONLY**. Failure to do so may cause property damage or personal injury.
-  **WARNING** Do not use this product to control an automatic pool cover. Swimmers may become entrapped underneath the cover.
-  **WARNING** For units intended for use in other than single-family dwellings, a clearly labeled emergency switch shall be provided as part of the installation. The switch shall be readily accessible to the occupants and shall be installed at least 10 feet (3.05 m) away, adjacent to, and within sight of, the unit.
-  **CAUTION** Except for listed spa-side remote controls, install a minimum of five (5) feet from the inside wall of the pool and spa.

FCC Standard - 47 CFR Part 15, Subpart C (Section 15.247). This version is limited to chapter 1 to chapter 11 by specified firmware controlled in the U.S.A.

Canada - Industry Canada (IC) - The IntelliChlor device complies with RSS210 of Industry Canada. (1999). Operation is subject to the following two conditions: (1) this device may not cause interference, and (2) this device must accept any interference, including interference that may cause undesired operation of the device.

Instruction to user - The IntelliChlor device has been tested and found to comply with the limits for a Class B digital device, pursuant to Part 15 of the FCC Rules. These limits are designed to provide reasonable protection against harmful interference in a residential installation. The IntelliChlor device generates, uses and can radiate radio frequency energy and, if not installed and used in accordance with the instructions, may cause harmful interference to radio communications. However, there is no guarantee that interference will not occur in a particular installation. If this device does cause harmful interference to radio or television reception, which can be determined by switching the device off and on, the user is encouraged to try to correct the interference by one or more of the following measures:

- Reorient or relocate the receiving antenna.
- Increase the separation between the equipment and receiver.
- Connect the equipment into an outlet on a circuit different from that to which the receiver is connected.
- Consult the dealer or an experienced radio/TV technician for help.

Note: The user is cautioned that changes and modifications made to the IntelliChlor device without the approval of the manufacturer could void the user's authority to operate this equipment.

General Installation Information

1. All work must be performed by a licensed electrician, and must conform to all national, state, and local codes.
2. Install to provide drainage of compartment for electrical components.
3. If this system is used to control underwater lighting fixtures, a ground-fault interrupter (GFCI) must be provided for these fixtures. Conductors on the load side of the ground-fault circuit-interrupter shall **not** occupy conduit, junction boxes or enclosures containing other conductors unless such conductors are also protected by a ground-fault circuit-interrupter. Refer to local codes for details.
4. A terminal bar stamped  is located inside the supply terminal box. To reduce the risk of electric shock, this terminal must be connected to the grounding means provided in the electric supply service panel with a continuous copper wire equivalent in size to the circuit conductors supplying this equipment (no smaller than 12 AWG or 3.3 mm). The bonding lug(s) provided on this unit are intended to connect a minimum of one No. 8 AWG for US installation and two No. 6 AWG for Canadian installations solid copper conductor between this unit and any metal equipment, metal enclosures or electrical equipment, metal water pipe, or conduit within 5 feet (1.5 m) of the unit.
5. The electrical supply for this product must include a suitably rated switch or circuit breaker to open all ungrounded supply conductors to comply with Section 422-20 of the National Electrical Code, ANSI/NFPA 70.1987. The disconnecting means must be readily accessible to the tub occupant but installed at least 10 ft. (3.05 m) from the inside wall of the pool.
6. Supply conductor must be sized to support all loads. Maximum supply conductor current must be 125 Amps at 125/220 VAC.

Two Speed Pump Controls Notice (Title 20 Compliance)

Please read the following important Safety Instructions - When using two-speed pumps manufactured on or after January 1, 2008, the pump's default circulation speed **MUST** be set to the **LOWEST SPEED**, with a high speed override capability being for a temporary period not to exceed one normal cycle, or two hours, whichever is less.

Technical Support

Contact Technical Support at:

Sanford, North Carolina (8 A.M. to 5 P.M.)

Phone: (800) 831-7133

Fax: (919) 566-8920

Moorpark, California (8 A.M. to 5 P.M.)

Phone: (800) 831-7133 (Ext. 6312)

Fax: (805) 553-5515

Web sites

visit www.pentairpool.com and staritepool.com

EasyTouch® 8 and 4 Pool and Spa Control System Kit Contents

The following items are included in the EasyTouch® 8 and EasyTouch 4 control system kit which may also include the IntelliChlor cell. If any items are missing please contact technical support.

- EasyTouch control panel (mounted in the load center)
- EasyTouch load center enclosure
- Two motorized valve actuators (CVA-24T P/N 263045) - Not included with single-body system
- Water sensor with 25 foot cable, o-ring and hose clamp (P/N 520272)
- Air sensor with 25 foot cable (P/N 520272)
- EasyTouch 8 and EasyTouch 4 Pool and spa Control System Installation Guide (this manual)

Optional Equipment

- IntelliChlor® Electronic Chlorine Generator Electrolytic Cell model IC20 (P/N 520554) or IC40 (P/N 520555)
- IntelliChlor User's Guide (P/N 520589)

About this manual

Use the information in this manual for installing the EasyTouch 8 or 4 Control System kit contents.

- For EasyTouch system operating instructions, refer to the EasyTouch User's Guide (P/N 520584)
- For Accessory installation and operation instructions, refer to the documentation provided with the accessory

EasyTouch Accessory Equipment

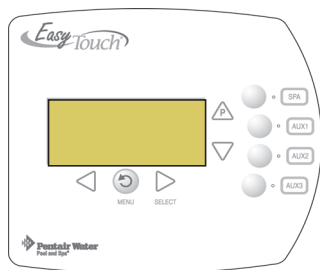

EasyTouch 4 Indoor Control Panel (P/N 520548)



EasyTouch 8 Indoor Control Panel (P/N 520549)



EasyTouch Wireless Control Panel (8 circuit) (P/N 520547)



iS10 Spa-Side Remote Controller (P/N 520149)



iS4 Spa-Side Remote Controller (P/N 520094)



QuickTouch® wireless remote controller (P/N 520148)

EasyTouch Accessory Equipment (continued)

EasyTouch Indoor Control Panel, 4 Circuits	(P/N 520548)
EasyTouch Indoor Control Panel, 8 Circuits	(P/N 520549)
EasyTouch Wireless Control Panel, 4 circuits	(P/N 520546)
EasyTouch Wireless Control Panel, 8 circuits	(P/N 520547)
iS4 Four-Function Spa-Side remote, 150 ft. cable	(P/N 520094)
S10 Ten-Function Spa-Side remote, 150 ft. cable	(P/N 520149)
Two-Speed Three HP Relay up to three additional valve actuators	(P/N 520198)
Three HP Power Relay	(P/N 520106)
QuickTouch four-function wireless remote kit with transceiver assembly	(P/N 520148)
IntelliChlor Acid Cleaning Kit	(P/N 520670)
IntelliChlor Spacer pass-through cell for new pool start-up	(P/N 520588)

EasyTouch System Installation Steps Summary

The recommended EasyTouch system installation steps are:

- 1 Prepare and install EasyTouch load center (pages 6-9):** Review high voltage Load center connections (see page 6). Prepare and install the EasyTouch load center at the equipment pad. AC power for the EasyTouch load center must be provided from the main-panel located at the house.
- 2 Remove EasyTouch load center knockouts/install conduit and wire to EasyTouch load center (pages 10-11).**
- 3 Install Auxiliary Relays and Valve Actuators (pages 15-16):** Install auxiliary relays and the valve actuators on the valve assembly and connect cables to the EasyTouch motherboard.
- 4 Install Temperature Sensors and Heat Thermostat (pages 17-18):** Install the water and air sensors and connect the cable plugs to the EasyTouch motherboard.
- 5 Connecting IntelliChlor cell (page 19):** Connect the IntelliChlor cell to the EasyTouch load Center. This optional equipment is include with IntelliChlor salt chlorine generator system only.
- 6 EasyTouch System Start-up (page 19):** Perform a system start-up procedure.

Required Tools

- 5/16 in. diameter drill (for mounting water temperature sensor).

Plumbing Requirements

It is important that the pool and spa plumbing system be in accordance with local codes and the Recommended Hydraulic Schematics (page 4 and 5). Before starting, please review the diagrams and the following recommended guidelines:

- 1 The spa should be at or above the level of the pool.

If the spa is attached to the pool, provide a dam between the two bodies of water to allow the spa to overflow into the pool. If the spa is not attached to the pool, an overflow, sufficient in size to carry a full pump-flow, must be installed at the water level in the spa.

- 2 Plumb a three-port **Intake Valve** on the suction-side of the filter pump, so that the center port of the valve is connected to the pump inlet. Connect the spa suction to one side of the Intake Valve, and the pool suction to the other side.

- 3 Plumb a three-port **Return Valve** on the return-side of the heater, so that the return water will enter the valve through the center port.

Connect the spa return to one side of Return Valve, and the pool return to the other side.

- 4 If required, install a spa makeup line (consisting of a manual gate or ball valve, for elevated spas install a check valve) to bypass the pool return line. This will enable some of the chemically-balanced water from the pool to cycle through the spa. The manual valve will allow the amount of bypass to be adjusted.

- 5 If the spa is to be constructed in concrete, special provision should be made at this time for the installation of the Spa-Side remote control.

Select a convenient location in the deck or above water level in the spa wall (where the Spa-Side remote will not be submerged by the spa water), and install a 6 in to 12 in length of one inch PVC pipe to provide a receptacle for the Spa-Side remote. The pipe should be level and protrude beyond the finished surface of the spa. It will be cut back later at installation time. Reduce the pipe size down to ½ in or ¾ in conduit, and run it to the proposed Load/Power Center location at the equipment pad. Use sweep elbows for turns.

The Spa-Side remote will not be installed until the spa construction is completed.

- 6 For systems which incorporate a skimmer, it is possible to balance the amount of suction between the skimmer and main drain for maintenance purposes. This is easily accomplished by installing a manual three-port mixing valve at the suction line. Plumb one port to the skimmer and the other to the main drain.
- 7 If a “non-booster pump” pressure-side pool cleaner is being used, plumb a manual three-port valve between the filter pump and filter, with the third port plumbed to the pool cleaner line, and install a motorized two-port **Pool Cleaner Valve** at this line. The motorized valve will automatically open whenever the Control System activates the pool cleaner.
- 8 If a booster pump pool cleaner is being used, plumb the booster pump so that its suction-side is connected to the pool return, after the heater, and as close to the ground as practical.

- 9 Plumb the solar feed and return lines between the filter and the heater. Install a three-port valve at the feed line. Use a solar valve (model SOL-2T), to allow automatic draining of the panels.
- 10 A solar booster pump should be used when the distance to the panels exceed 200 ft., or the panels are elevated higher than 25 ft.
- 11 Glazed solar panels require a drain valve (model HW-5B) to allow draining of the panels. This prevents damage from overheating water. Install a drain valve at the solar feed line and connect to the pool fill line.
- 12 **SCG systems only:** IntelliChlor IC40 or IC20 salt chlorine generator (SCG) cell with check valve at the heater output. Refer to IntelliChlor User's Guide (P/N 520589) for plumbing requirements.

Equipment Location

All equipment, with the exception of the spa-side remote, must be located at least 10 ft. from the water's edge.

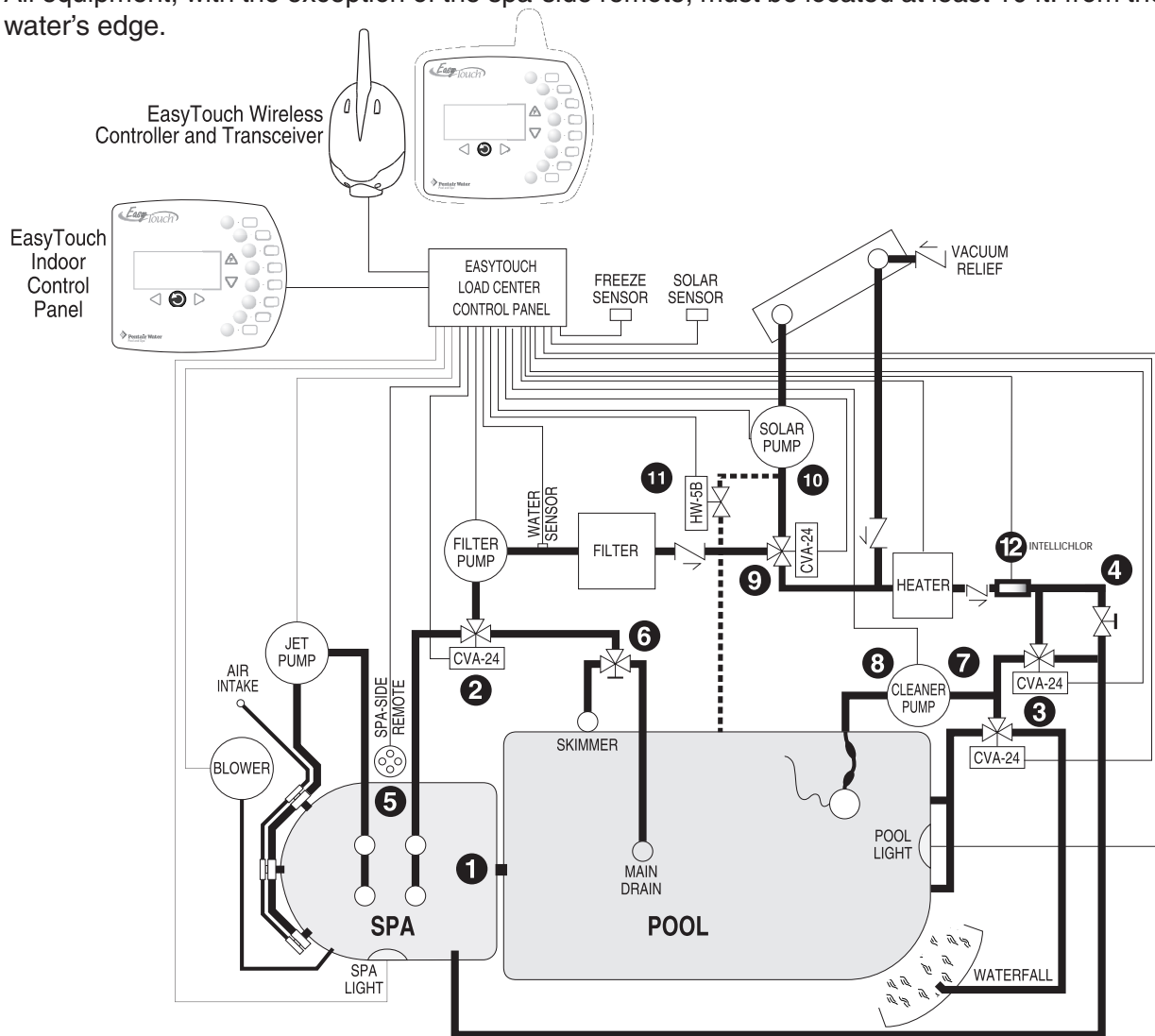

Recommended Hydraulic Schematic for Shared Equipment System

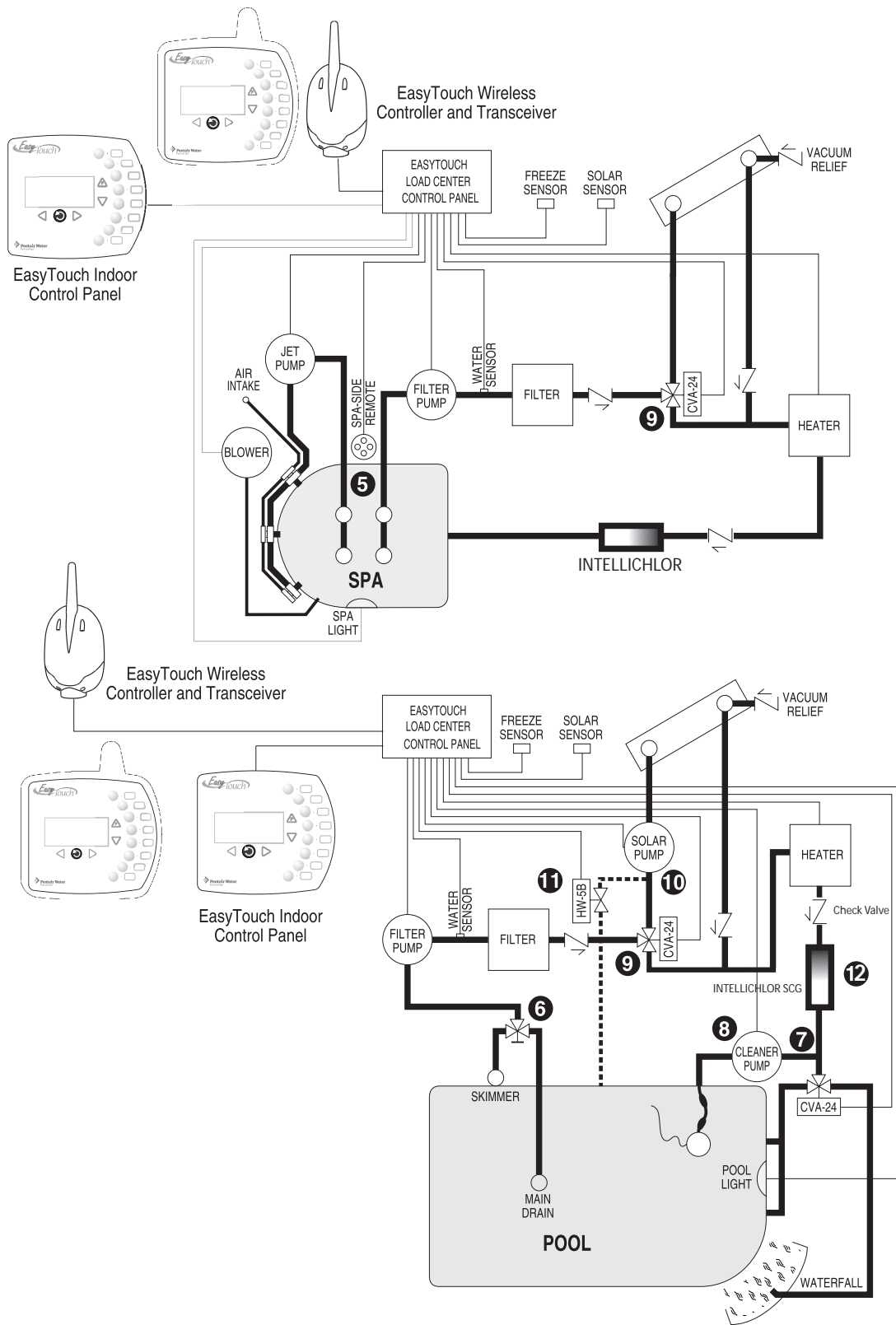

Recommended Hydraulic Schematic for Single Body System

EasyTouch Load Center High Voltage Connections

The EasyTouch load center enclosure includes a 125/220 VAC 125 AMP circuit breaker base (sub-panel), high-voltage power relays, transformer, and low voltage circuit breakers.

⚠ WARNING - BEFORE REMOVING THE HIGH VOLTAGE COVER PANEL FROM THE ENCLOSURE switch the main power **OFF** into the home at the main circuit breaker box. Also, switch **OFF** the main power to the EasyTouch load center before removing the high voltage cover panel to access the low voltage raceway.

EasyTouch Load Center Location

Before installing the EasyTouch load center read the following guidelines:

- AC power for the EasyTouch load center must be provided from the main circuit breaker panel located at the house.
- All electrical equipment, except for UL Listed spa-side remote switches, must be installed at least five (5) feet from pool and/or spa, and comply with all national, state, and local codes (UL Listed spa-side remote switches may be installed at near waterline).
- Install the EasyTouch load center no less than five (5) feet from pool or spa near to the pumps, heater, valves, and sensors. Mount the enclosure outside or inside a pool equipment house or other enclosure.
- Before choosing the final location for the EasyTouch load center, consider the length of the wires and valve wires that have to be connected to the enclosure. Make sure to consider cable lengths for the sensors to the EasyTouch load center location. The Air Temperature Sensor cable is 3 feet long and the Water Temperature Sensor is 25 feet long.
- Mount the EasyTouch load center on a flat vertical surface or wall so that the conduit knockouts are located at the bottom of the enclosure. Upper and lower brackets are provided to mount the enclosure to a vertical surface.
- DO NOT mount the EasyTouch load center enclosure horizontally. Water can enter the conduit knockouts and cause damage to the system and an electrical shock hazard.
- Consider the EasyTouch load center location when routing the conduit carrying the AC power to the EasyTouch load center, and the conduit that will be run to the high voltage equipment.
- Install the EasyTouch load center so that drainage is provided for all electrical components.
- Motors should have built-in thermal protection.
- Allow for unobstructed access to the front of the EasyTouch load center for the owner or service personnel.
- The EasyTouch load center provides grounding screw terminals for grounding all equipment. All equipment including the EasyTouch load center enclosure must be bonded to earth ground.

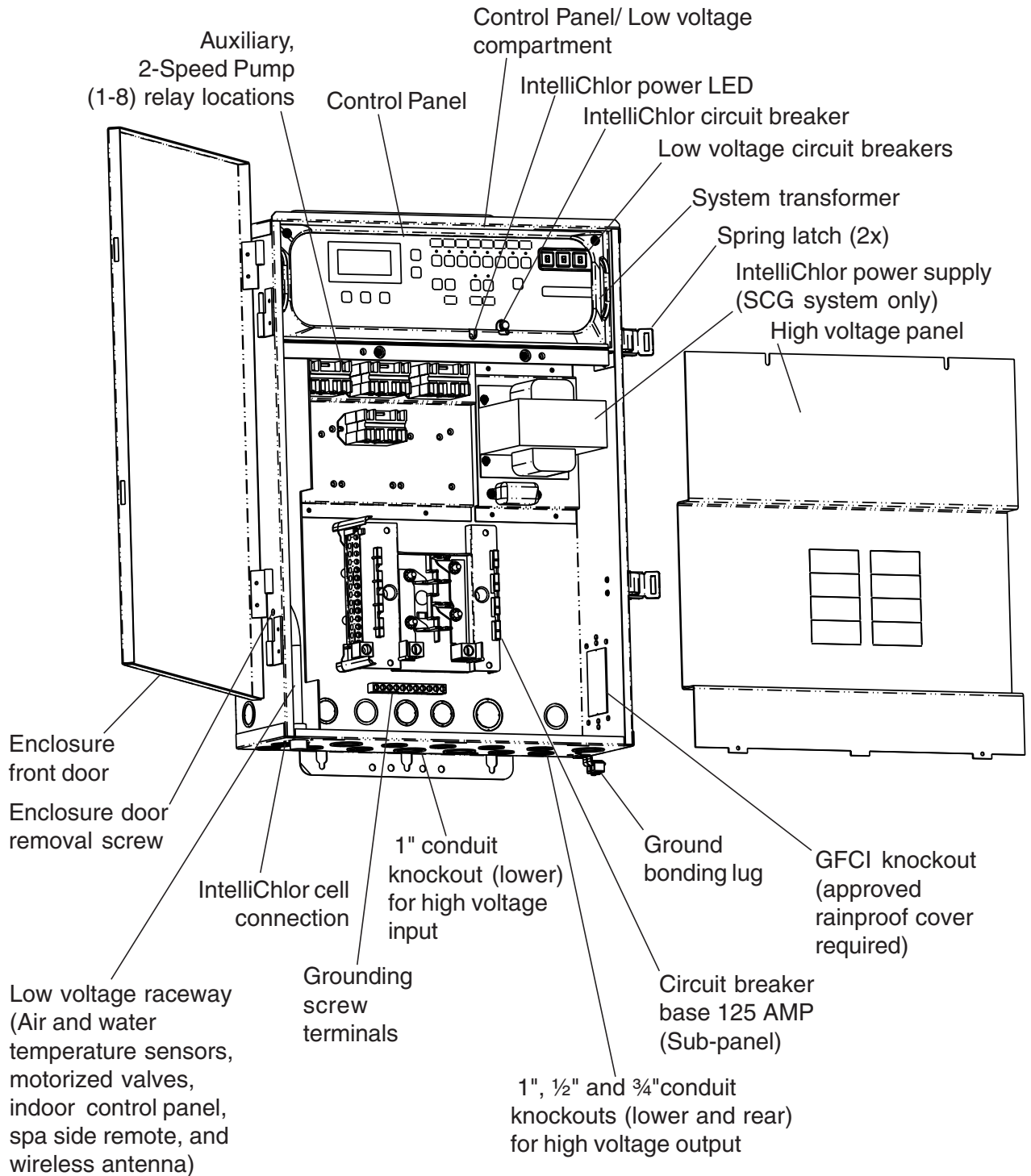

EasyTouch Load Center
(23" H x 17" W x 4 3/4" D)

Preparing the EasyTouch Load Center Enclosure

Before mounting the EasyTouch load center, first remove the front door and the high voltage panel to access the conduit knockouts and low voltage raceway.

To remove the EasyTouch load center front door and high voltage panel

1. Unpack the load center from the shipping box.
2. Unlatch the front door spring latches, and open the front door.
3. Remove the front door screw located above the lower hinge. Remove the front door from the hinges.
4. Remove the screws securing the high voltage cover-panel. Remove the cover-panel from the enclosure.
5. Proceed with:
 - **Mounting the EasyTouch Load Center**, page 9
 - **Removing Electrical Conduit Knockouts**, page 10
 - **Installing Conduit and Wire to the EasyTouch Load Center**, page 11
 - **EasyTouch Motherboard Connections**, page 13
 - **Accessing the EasyTouch motherboard**, page 14
6. After electrical connections have been completed, reinstall the enclosure door on its hinges and install the door release screw. Reinstall the high voltage panel and secure with the retaining screws.

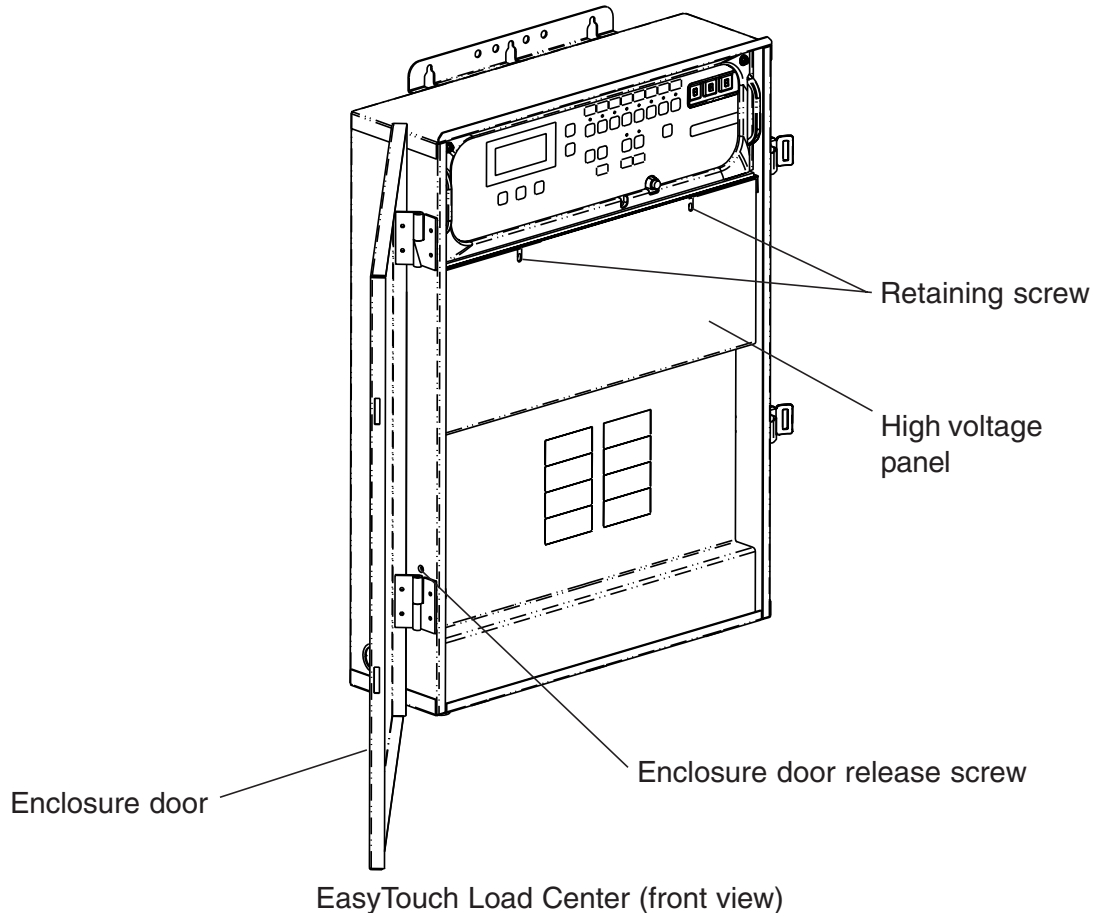

Mounting the EasyTouch Load Center

The EasyTouch load center can be mounted on a flat vertical surface, such as a wall or post.

To mount the EasyTouch load center:

1. Position the EasyTouch load center against the vertical flat surface. If wall anchors are being used, support the EasyTouch load center enclosure in position (horizontally level and square) against the surface and mark the bracket hole pattern on the wall.
2. Secure the enclosure with three (3) screws in the top and lower mounting bracket holes. If using wall anchors, drill and set the anchors and secure the enclosure with screws.

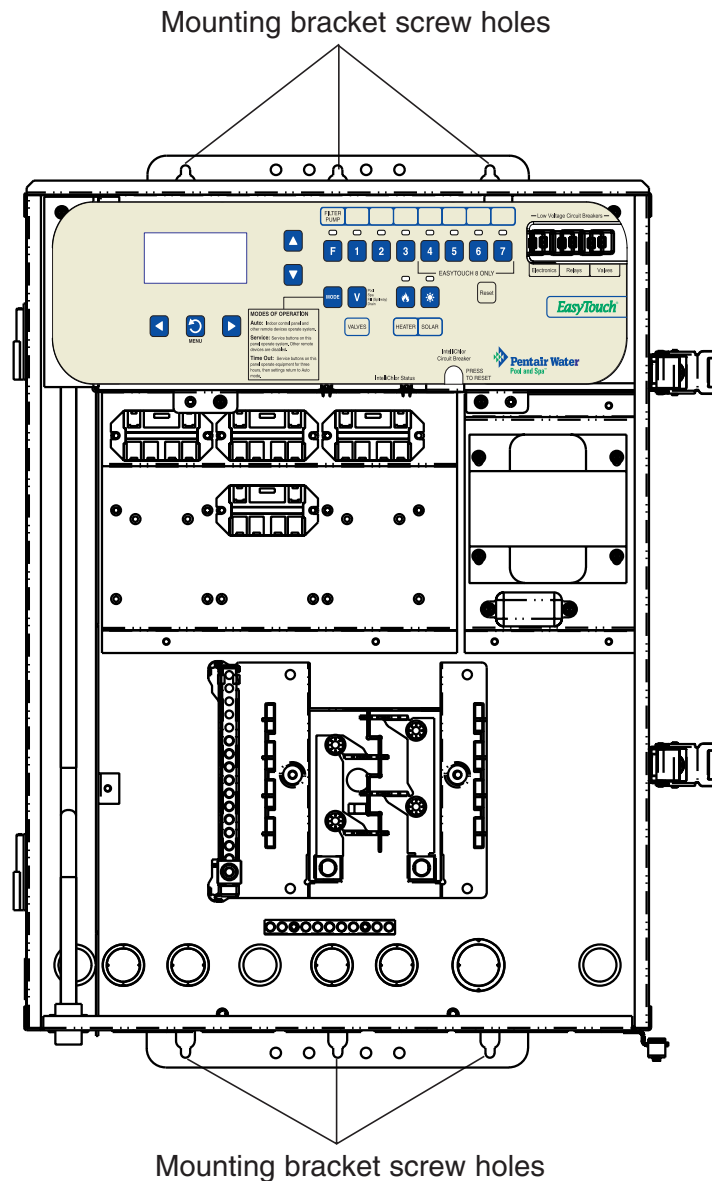

EasyTouch Load Center (front view)
with front door and
high voltage panel removed

Removing Electrical Conduit Knockouts

Before installing EasyTouch load center electrical conduit, read the following recommended guidelines:

- Determine the number of low and high voltage circuits being used in the EasyTouch load center, the conduit size and runs needed based on the wire size, and the number of conductors within the conduit. The EasyTouch load center conduit knockout sizes are 1", 1/2" and 3/4".
- The EasyTouch load center conduit knockouts are located on the bottom and back of the enclosure. Conduit knockout sizes are 1", 1/2" and 3/4". It is recommended to use 1" conduit for the main AC power conductors. The 1" AC power conduit knockouts are located directly under the main enclosure circuit breaker.
- The EasyTouch load center enclosure must be located a minimum of 5 ft. from the inside wall of pool or spa.

Remove the enclosure conduit knockouts as needed:

- Low voltage raceway has three 3/4" holes located on the left side of the enclosure.
- High voltage compartment has four 3/4" x 1" and eight 1/2" x 3/4" conduit knockouts located underneath the front of the enclosure.

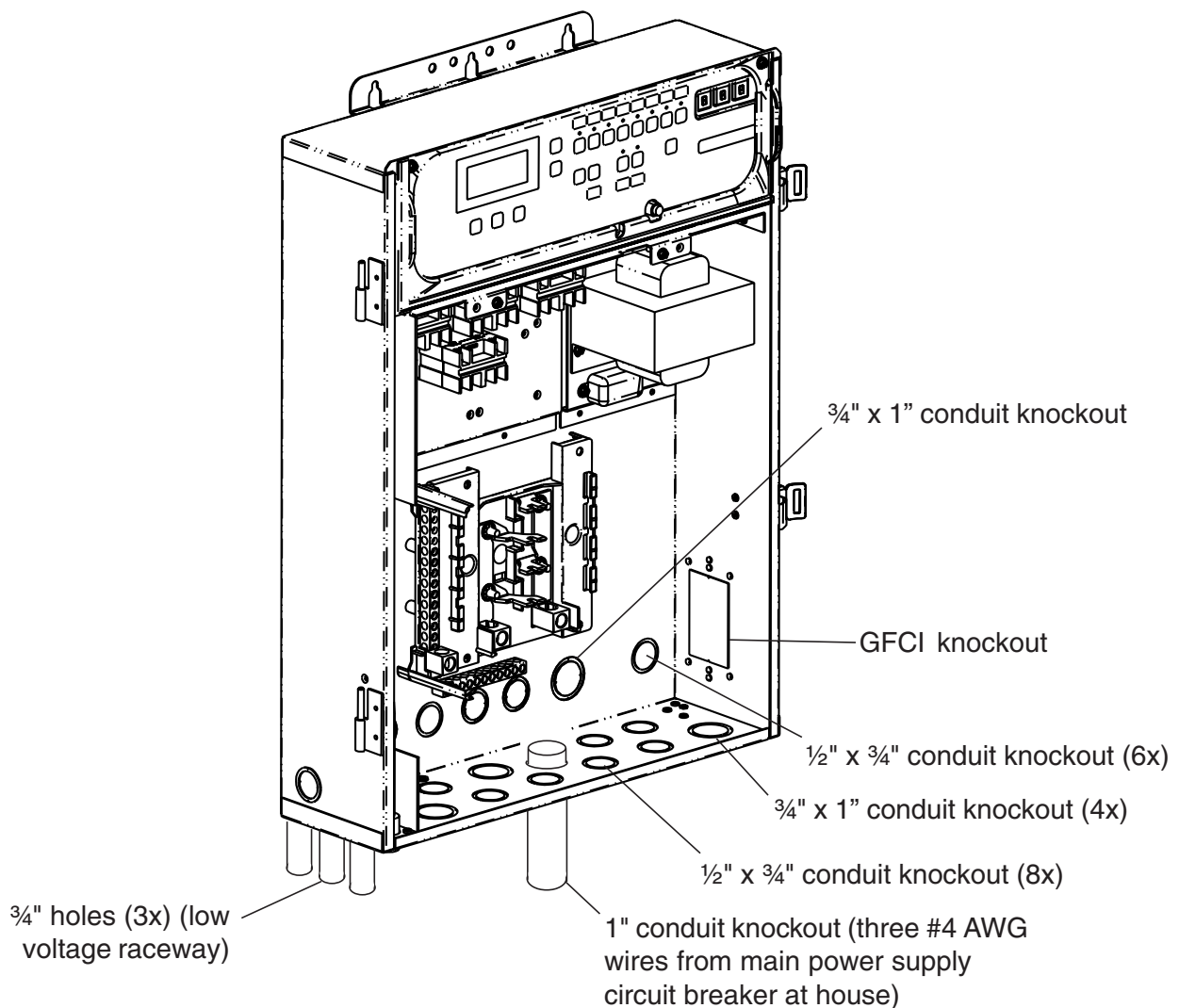

Installing Conduit and Wire to the EasyTouch Load Center

Before installing electrical conduit, read the following recommended guidelines:

- Determine the number of low and high voltage circuits being used in the EasyTouch load center, the conduit size and runs needed based on the wire size, and the number of conductors within the conduit.
- Use 14 minimum to 6 maximum AWG for relay circuits depending on the load requirement. Be sure to follow all regulation safety codes for the number and size of conductors that can be installed in various sizes of conduit.
- Recommended power supply cable to the EasyTouch load center should have a minimum supply conductor current of 40 AMP (at 230 VAC using 8 AWG).
- Supply circuit must be protected by suitable breaker rated no higher than 125 AMP.
- To avoid obstruction into the EasyTouch load center, when using electrical conduit complete the installation of the conduit before concrete is poured. Also, underground conduit should be positioned in well compacted soil. Ensure that all conduit joints are well sealed and watertight.

To install electrical conduit and wires as needed:

⚠ WARNING - TO AVOID AN ELECTRICAL HAZARD - Do not connect the power source conductors to the EasyTouch load center circuit breaker until all electrical connections for all loads (heaters, pumps, motorized valves, and lights etc.) have been completed.

- Use the one of the three low voltage raceway 3/4" holes located on the underside of the enclosure for the temperature sensor wires (see page 17).
- For the AC power wire into the EasyTouch load center from the main circuit breaker at the house, use three conductors, one each for red, black, and white (or red, red and black for 220 VAC). The maximum load is 125 AMP at 120 VAC/240 VAC 60 Hz/50 Hz. These conductors should be secured to supply side of circuit breaker base. Use a 1" conduit run for these power conductors. For the main AC power conduit, it is recommended to use the 1" conduit knockout located directly under the enclosure circuit breaker.

⚠ CAUTION All of the electrical wiring methods and materials used to complete the electrical installation of the EasyTouch Pool/Spa Control System must be in accordance with the National Electrical Code or the Canadian Electric Code, as well as any local electrical codes in effect at the time of installation.

⚠ CAUTION All electrical materials used for the EasyTouch installation must be accomplished by, or be under the direct supervision of a qualified electrician.

Installing Conduit and Wire to the EasyTouch Load Center (Continued)

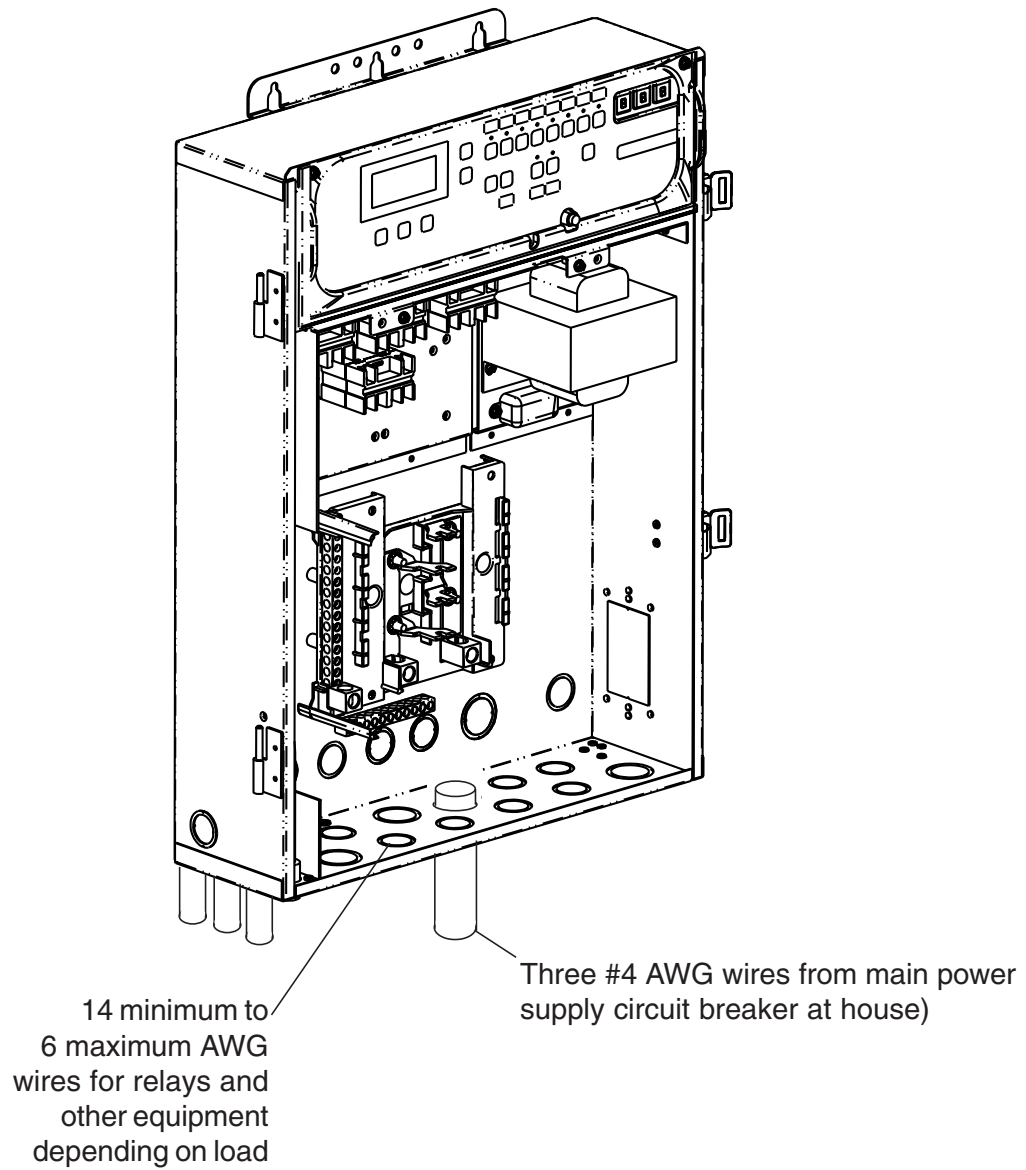

EasyTouch Load Center (front view)
with front door and
high voltage panel removed

EasyTouch Motherboard Connections

The EasyTouch system motherboard is mounted onto the back of the main load center control panel. The motherboard provides the voltage connections to switch the filter pump, heater, auxiliary relays, motorized valves, and connections for temperature sensors, EasyTouch Indoor Control Panel and iS4 Spa Side remote. To access the motherboard, refer to “Accessing the EasyTouch Motherboard,” on page 14.

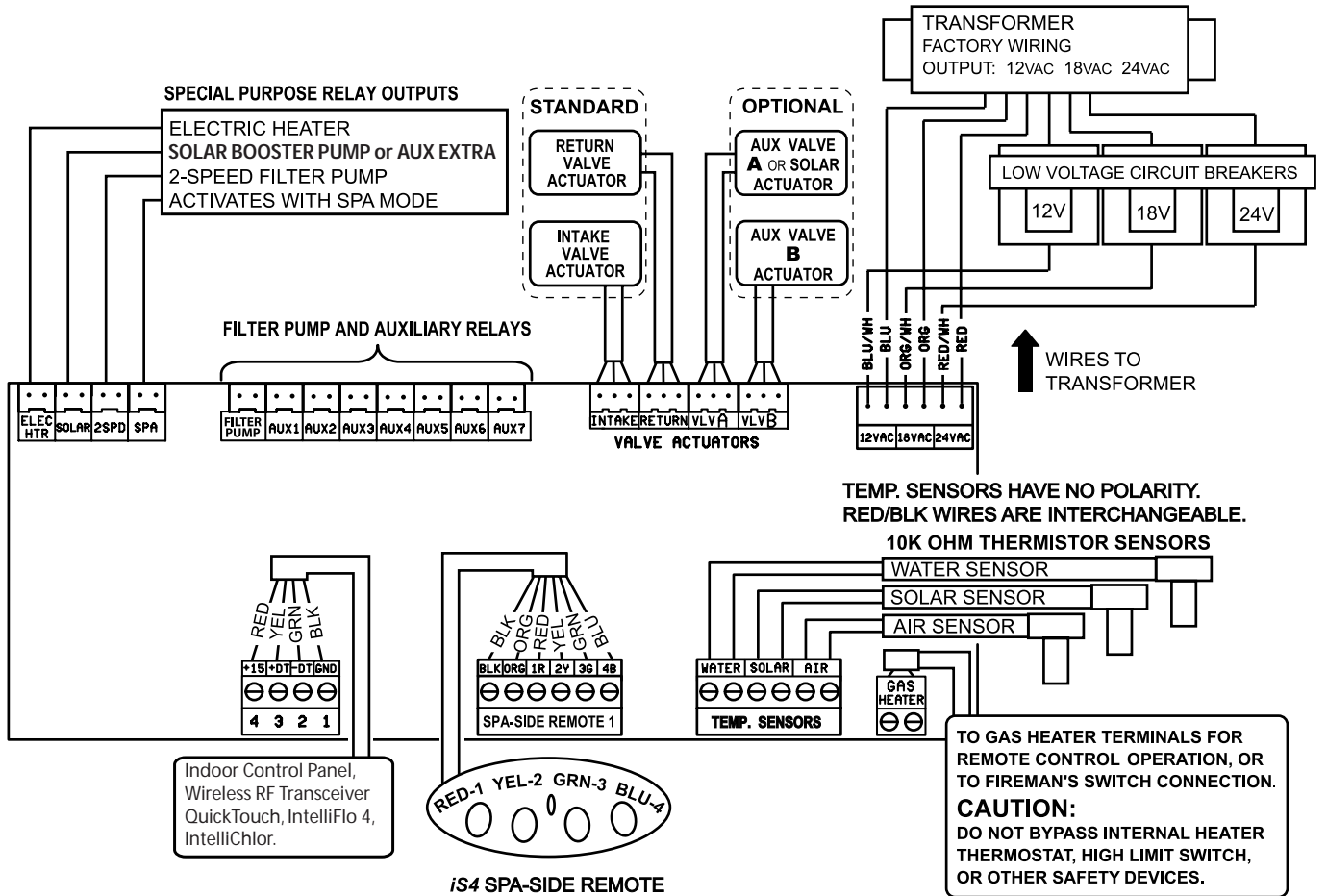

EasyTouch Motherboard Connections

Accessing the EasyTouch Motherboard

The EasyTouch motherboard provides connectors for the auxiliary relays, valve actuators and sensors (see page 13). To access the motherboard connectors, fold down the main control panel.

To access the motherboard connectors:

1. Loosen the two retaining screws securing from the top edge of the control panel.
2. Fold down the control panel to access the rear of the motherboard for the electrical connections.
3. Proceed with:
 - **Installing Auxiliary Relays**, page 15
 - **Installing the Valve Actuator**, page 16
 - **Installing and Connecting Temperature Sensors**, page 17
 - **Connecting the Heater Thermostat**, page 18
4. After electrical connections have been completed, close the control panel and tighten the two retaining screws.

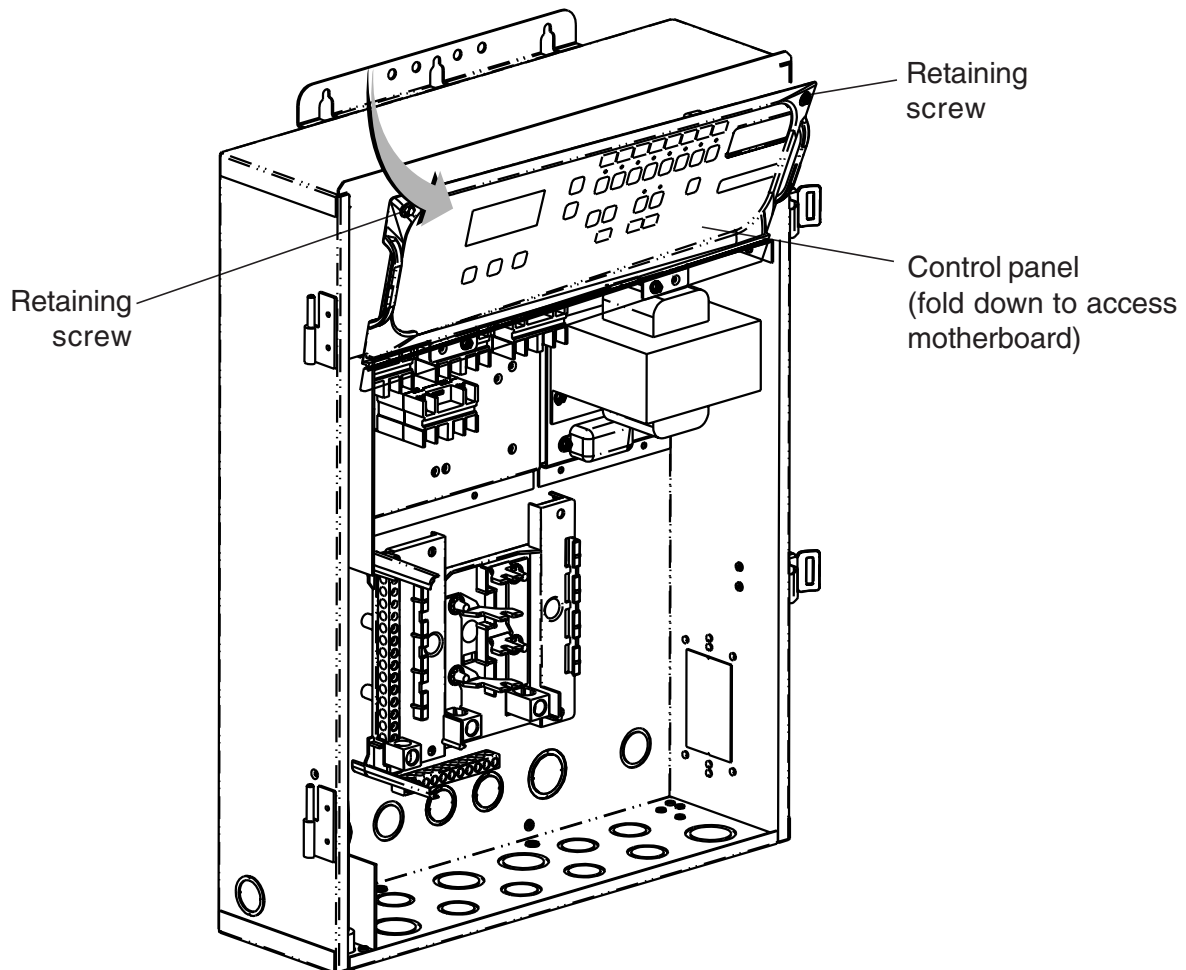

Installing Auxiliary Relays

Install the optional auxiliary relays as needed.

To install a relay:

1. Install optional auxiliary relays below the pre-installed relays. Secure in place with two retaining screws. Depending on the EasyTouch model, there may be up to 5 available relay positions (EasyTouch 8 includes eight relays and EasyTouch 4 includes four relays).
2. Route the relay cable plug up through the holes into the low voltage compartment to the motherboard.
3. Insert the relay plug into one of the two-pin sockets on the motherboard. For motherboard connection details, refer to “EasyTouch Motherboard Connections,” on page 13. For wiring details, refer to the “EasyTouch System Wiring Diagram,” on page 23.

Note: Install the optional Two-Speed Pump relay (P/N 520198) cable plug into the 2SPD two-pin socket on the Personality board. For installation and operation information, refer to the Two-Speed Relay User’s Guide (P/N 520210).

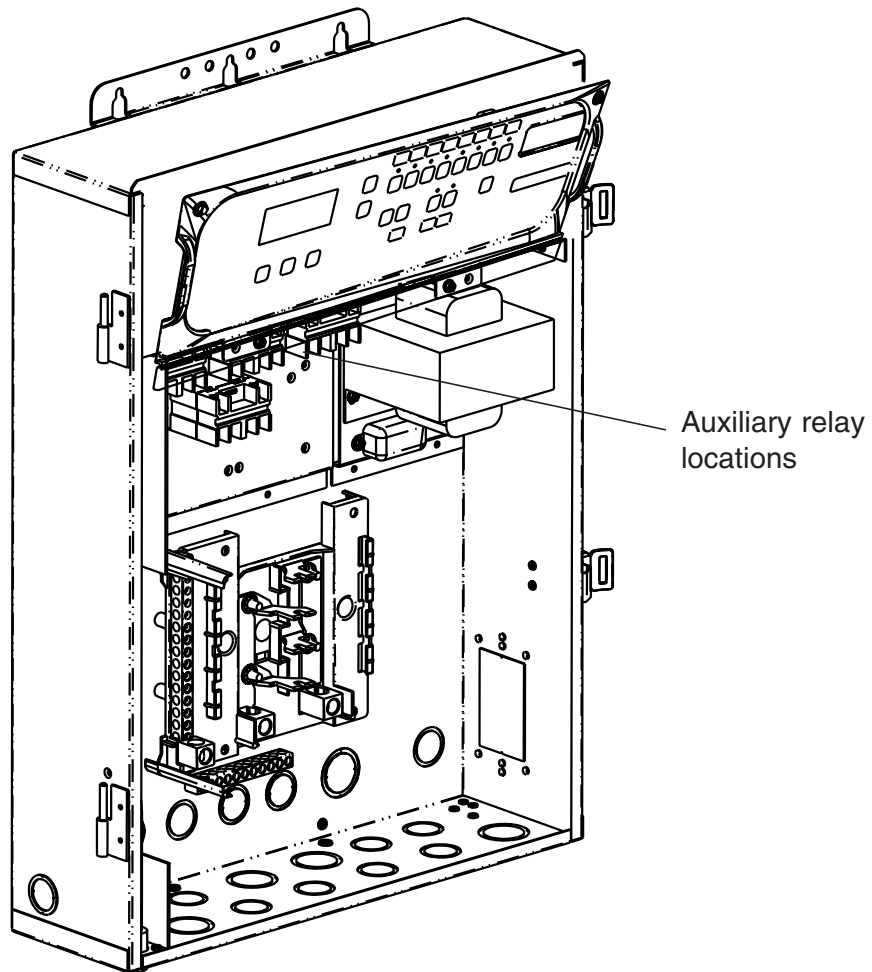

Installing Valve Actuators

For shared equipment systems there are two motorized valve actuators (CVA-24T, P/N 263045). To install the valve actuators:

1. Remove the valve knob, handle and the four screws, from the valve cover (indicated with arrows).
2. Align the splines of the actuator shaft over the shaft of the valve.
3. If the actuator is not aligned with the mounting holes on the valve cover, rotate the actuator (while still attached to the valve) until the actuator is positioned correctly over the valve.
4. Secure the actuator with the screws provided. Only use self-tapping screws when required.
5. Mount the valve handle and knob onto the actuator.

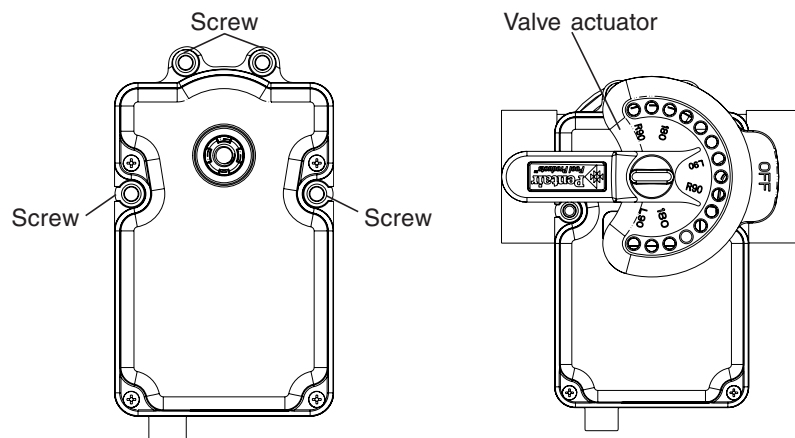

Valve Module Expansion Board:

Three additional valve actuators can be added to the system if necessary using a Valve Module Expansion board (P/N 520285). The expansion board attaches to the edge of the Personality board. For installation and operation information, refer to the IntelliTouch Valve Actuator Installation Guide (P/N 520294).

6. At the Load Center, route the cable up through the 1" grommet and low voltage raceway to Personality board.
5. Connect the Valve A actuator cable plug into the **INTAKE** (suction) 3-pin socket, and Valve B actuator cable plug into the **RETURN** three-pin socket on the right side of the motherboard (for more information, see Item 2 and 3 of Plumbing requirements on page 3). For motherboard connection details, refer to "EasyTouch Motherboard Connections," on page 13. For wiring details, refer to "EasyTouch System Wiring Diagram," on page 23. Excess cable can be coiled in the enclosure low voltage raceway left side compartment. Do not coil the wire in upper low voltage compartment.

For Solar Heating use **VLV A** (3-pin socket). Use **VLA B** (3-pin socket) for an optional auxiliary relay.

Adjusting the valve position

If the valve rotates to the wrong position, adjust the switch on the back of the actuator between ON1 and ON2 positions. This will rotate the valve to the correct position. The following diagram shows the standard plumbing and valve actuator position.

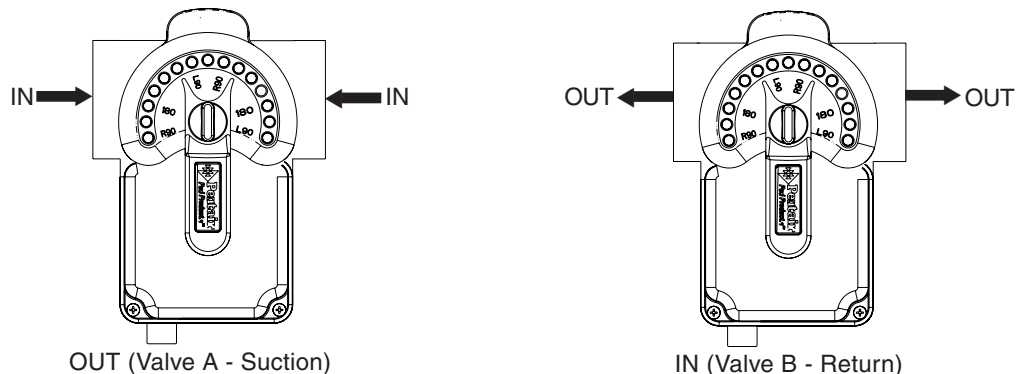

Installing and Connecting Temperature Sensors

Water Temperature Sensor

To install the water sensor:

1. Select a convenient location to mount the water sensor in the plumbing system between the filter pump and filter. Drill a 5/16" diameter hole in one side of the pipe,
2. Insert tip of sensor into the hole. Use the band clamp to secure the sensor to the pipe. Tighten the clamp just enough so that the o-ring begins to flatten. Do not overtighten
3. Run 22 gauge two-conductor cable (included in kit) between the sensor and the Personality board. Route the wire up through the Load Center low voltage raceway to the Personality board.
4. Fasten the cable to the plumbing with cable ties.
5. Cut off the excess wire and the strip conductors ¼ inch. Use waterproof connectors (provided) to connect the sensor to cable. Insert the wires into the **WATER SENSOR** screw terminals (**J21**) on right-side of the motherboard. For motherboard connection details, refer to "EasyTouch Motherboard Connections," on page 13. For wiring details, refer to "EasyTouch System Wiring Diagram," on page 23.

Ambient Air Temperature Sensor (for freeze protection)

To install the air sensor:

1. Mount the sensor in the open air, in a shaded area, away from air conditioners. During the winter months, to avoid freeze damage to pool and spa equipment, mount the air sensor in a shaded area to assure proper temperature readings. The main screen displays the current ambient air temperature.
2. Route the wire through the low voltage raceway to the motherboard.
3. Fasten the cable to the plumbing with cable ties.
4. Cut off the excess wire and the strip conductors ¼ in. Insert the wires into the **AIR** screw terminals (**J21**) on right side of the motherboard.

Solar Temperature Sensor (Optional)

Run a two-conductor cable between the sensor and the IntelliTouch Load Center.

To install the solar sensor:

1. Mount the sensor on a flat surface, with the same exposure to sun as the solar collectors (next to the collectors is recommended) or any sunny location. Do not let the sensor touch the panels. **WARNING: DO NOT DRILL HOLE AND CLAMP SENSOR INTO SOLAR PIPE.** For glazed panels, install the sensor between collector and glazing.
2. If necessary, splice a two-conductor extension wire to the sensor. Run two-conductor cable between the sensor and the Load Center. Use waterproof connectors to connect the sensor to the cable. Use twisted pair 20 AWG outdoor rated sensor wiring and be sure the wire connections are protected from the environment. Use shielded cable for long runs or runs near other electrical wiring.
3. Strip the conductors ¼ in. Insert the wires into the **SOLAR SENSOR** screw terminals (**J21**) on right side of the motherboard.

Connecting the Heater Thermostat

The following installation instructions are for gas heaters and heat pumps with low voltage thermostats.

To connect the heater thermostat cable plug to the motherboard:

1. Run a two-conductor cable from the heater thermostat area to the low voltage raceway to the motherboard in the EasyTouch load center.
2. Strip the conductors $\frac{1}{4}$ in. Insert the wires into the **GAS HEATER** two-screw terminals (**J19**) on the motherboard. For wiring details, refer to “EasyTouch System Wiring Diagram,” on page 23.
3. At the heater, connect the wires in accordance with heater manufacturer’s instructions. For older heaters without instructions for remote operation, connect the wires to the Fireman’s switch connections in series with the thermostat, pressure switch, and other safety switches.
4. Do NOT disconnect or wire around the thermostat, pressure switch, high limit switch, or other safety devices.
5. Select the pool or spa thermostat and toggle the heater to that setting.
6. Turn the thermostat for the selected setting to maximum.

Connecting the IntelliChlor Cell

The following connection instructions are for the optional IntelliChlor electronic chlorine generator (model IC20 and IC40). After the IntelliChlor cell unit has been installed, connect the cell power cable to EasyTouch load center.

To connect the IntelliChlor power cable to the EasyTouch load center:

1. Switch AC power OFF to the EasyTouch load center.
2. Align the four pins of the IntelliChlor cell power connector with the socket on the bottom of the EasyTouch load center enclosure and insert the connector into the socket.
3. Rotate the socket nut until it locks the connector in place. Do not over tighten the nut (hand tighten only).
4. Switch AC power ON to the EasyTouch load center.

⚠ WARNING - TO AVOID AN ELECTRICAL HAZARD AND EQUIPMENT DAMAGE TO LOAD CENTER AND INTELLICHLOR CELL: FIRST DISCONNECT AC POWER TO THE EASYTOUCH LOAD CENTER BEFORE CONNECTING THE INTELLICHLOR CELL COMMUNICATION CABLE TO THE LOAD CENTER CONNECTOR.

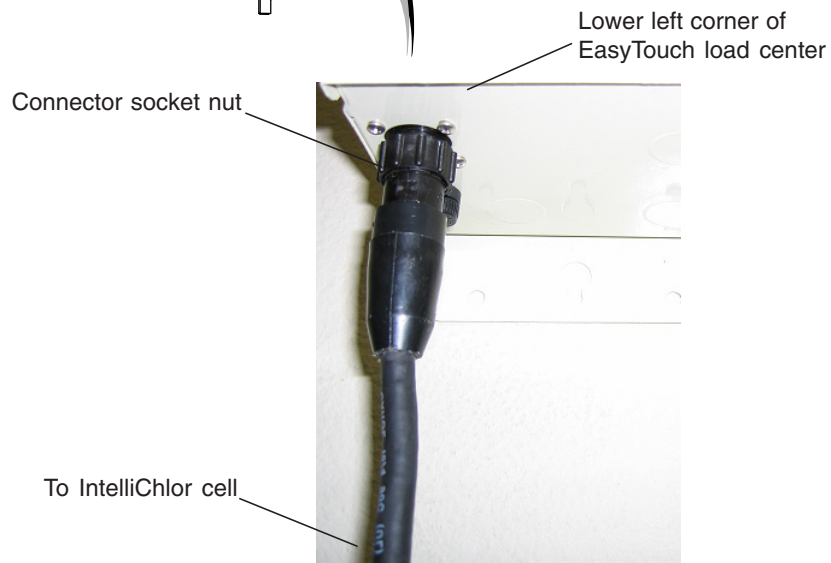
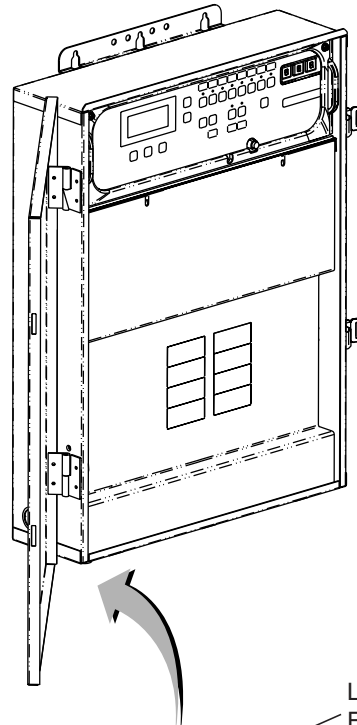

Rewiring the IntelliChlor Transformer for 115 VAC

The IntelliChlor power supply transformer located in the EasyTouch load center can be wired for 220 VAC or 115 VAC. The IntelliChlor transformer is pre-wired at the factory for 220 VAC service.

To rewire the IntelliChlor transformer and EMI filter for 115 VAC:

⚠ WARNING - BEFORE REMOVING THE HIGH VOLTAGE COVER PANEL FROM THE EASYTOUCH LOAD CENTER ENCLOSURE switch the main power **OFF** into the home at the main circuit breaker box and also switch **OFF** the main power to the EasyTouch load center.

1. Switch the power off to the EasyTouch load center.
2. Unlatch the two front door latches and open the front door.
3. Remove the two retaining screws from the high voltage panel and remove the panel.
4. Rewire the Transformer and filter for 115 VAC as shown in the 115 VAC wiring diagram below.
5. Install the high voltage panel and secure it with the two retaining screws.
6. Close the enclosure front door and secure with the latches.

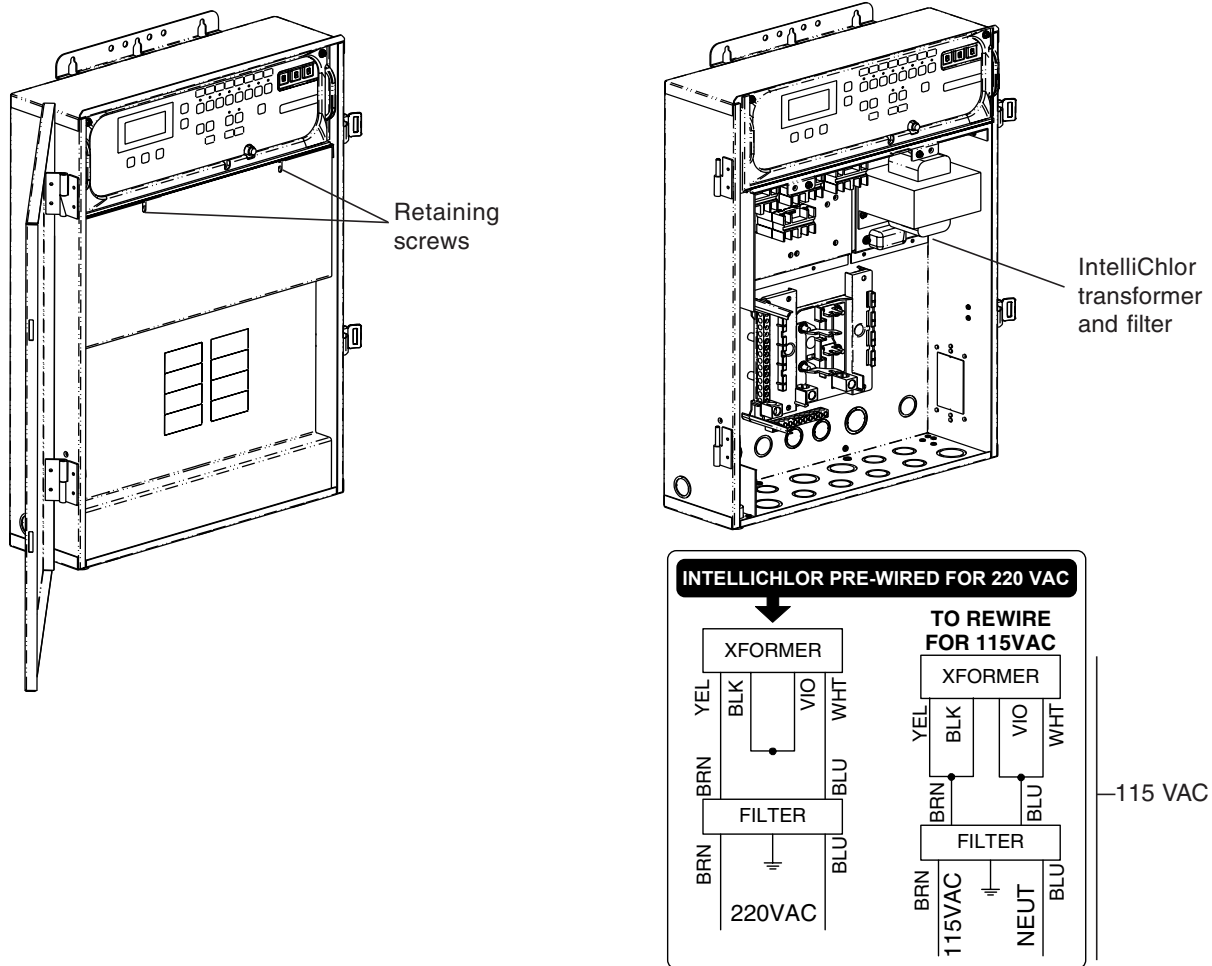

IntelliChlor transformer and filter wiring diagram

EasyTouch System Start-Up

Perform the following start-up procedures to ensure that the EasyTouch load center is installed correctly. If you need more detailed operating information, refer to the EasyTouch Pool and Spa Control System User's Guide (P/N 520584).

Before you power up the EasyTouch load center check the following:

Check Electronics

Check that the following plugs are seated correctly on the motherboard:

- Relay connectors - **FLTR PUMP - AUX1 - AUX7 (EasyTouch 8), AUX1 - AUX3 (EasyTouch 4)**
- Temperature sensors connectors **WATER, SOLAR, AIR**
- Transformer wire harness (**J1**) attached to the motherboard.
- Heater control connector **ELEC HTR** or two-wire screw terminal.

Refer to Summary Installation Steps (page 2) and EasyTouch System Wiring Diagrams, on page 23.

EasyTouch System Test

The following describes how to test the main control panel to activate the heater, valves and pumps. Before testing the system, be sure that all pool and spa equipment has been properly installed and connected to the EasyTouch load center.

Testing Valve Actuators and Filter Pump

Use the following steps to test the valve actuators (CVA24T) for proper rotation.

To test the valve actuators and pump:

1. Power up the EasyTouch load center.
2. Press the **Mode** button on the main control panel. The display shows "SERVICE".
3. Press the **Valve (V)** button to select **POOL**.
4. Press the **Filter Pump (F)** button to activate the filter pump. Water will be removed from the pool and returned to the pool.
4. Repeat steps 3 and 4 selecting **Fill (Spillway)** then **Drain**.
5. Set both valve actuators (CVA-24T) for suction and return. Use the toggle switch on the rear of the CVA-24T to withdraw and return water from the pool.

Note: With the filter pump operating, if the water is not being removed and returned to the pool, check that the valve actuator plugs are connected correctly on the motherboard.

Testing the auxiliary relays

Affix the auxiliary relay labels to the appropriate AUX buttons on the EasyTouch control panel to identify the connected equipment.

- Press the **Mode** button to enable "Service" pool mode. Press the Filter Pump button (LED on) and each auxiliary (AUX) circuit button, the Heater and Solar buttons to verify the functions. Press the **Mode** button twice to return the system to "**AUTO**" mode when done.

Verifying IntelliChlor power

After the IntelliChlor cell has been connected to the EasyTouch Load center, check the following IntelliChlor cell LEDs to verify that the IntelliChlor is powered up (see page 7).

- Verify that the green IntelliChlor status LED is lit on the EasyTouch load center control panel.
- Verify that the green IntelliChlor power LED is lit on the IntelliChlor cell. See the IntelliChlor User's Guide (P/N 520589) for more troubleshooting information.
- Use the following troubleshooting table if the IntelliChlor green status LED is not on.

Troubleshooting IntelliChlor

Problem	Possible Cause	Corrective Action
The IntelliChlor power LED is not on. The power LED is located on the EasyTouch Load Center control panel.	Fuse in EasyTouch Load Center is open.	Reset the AC fuse, located in the EasyTouch control panel.
	No AC power to EasyTouch Load Center.	Verify 110 VAC or 220 VAC to EasyTouch Load Center when active.
	Transformer leads not wired correctly in EasyTouch Load Center.	Verify transformer leads wired to AC source by referring to wiring diagram on page 23.



WARNING

PREVENT ELECTROCUTION
 INSTALL AT LEAST 5 FEET FROM INSIDE WALL OF SPA OR POOL.
 DISCONNECT ALL CONNECTIONS BEFORE SERVICING THIS UNIT.
 THIS APPLIANCE HAS UP TO 10 SUPPLY CONNECTIONS.

RAINFOOF (TYPE 3R) CONTROL PANEL, FOR INDOOR OR OUTDOOR USE.
SUITABLE FOR SWIMMING POOL/SPA APPLICATIONS
 120V/240V 125 AMP MAX, SINGLE PHASE.
 60 - 70°C, MIN. INSULATION: REQUIRED ON ALL FIELD WIRING.
SHORT CIRCUIT RATING: 5000 SYMMETRICAL AMPERES.
TRANSFORMER INPUT: 120V, 2A., 50/60Hz;
 240V, 2 WIRES, 1A., 50/60Hz.
CAUTION: RISK OF ELECTRIC SHOCK, READ INSTALLATION MANUAL.
IMPORTANT: This control panel must be installed according to the National Electrical code (including article 680) and local requirements. Mount with conduit hole down. The main lugs and neutral main are suitable for No. 14 to 2 AWG conductors. Use No. 14 to 6 AWG COPPER or ALUMINUM conductors for branch circuit wiring. Install interchangeable circuit breakers designed to fit the control panel interior, see list of suitable types below. Follow manufacturers instructions for installing and testing of ground fault circuit breakers (GFCB) and interrupters (GFCI). Additional approved wiring devices may be installed in the rectangular side knockout or inside the enclosure, provided the wiring devices have lead connections. Otherwise, the device with uninsulated terminals must be covered by internally installed metallic or nonmetallic wall box. When using side knockout, an approved rainproof cover must be installed over the wiring device if used outdoors. Make sure connections to low voltage compartment are sound and properly insulated. After wiring, install front panel over wiring compartment and close unused breaker openings with filler plates.

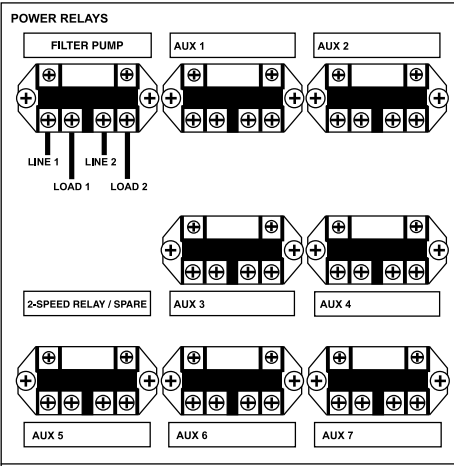
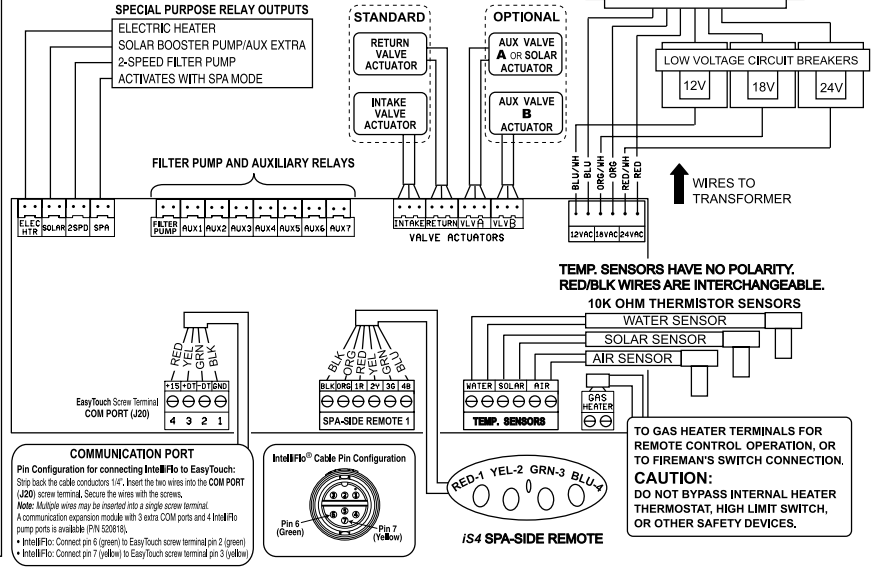

NOTE: AUX 4 thru 7 provided with EasyTouch 8 ONLY.

A disconnecting means must be located within sight from the equipment and at least 5 feet (1.52 m) from the inside walls of the pool, spa or hot tub.

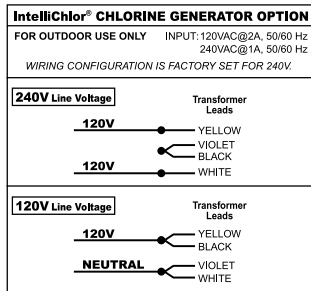
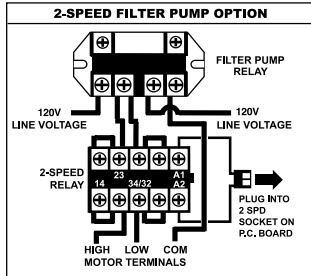

PREVENT WATER DAMAGE KEEP DOOR CLOSED

RELAY CONTACT OUTPUT	
General: 25A, 277VAC	
PUMP	LIGHT
1.5 HP 120 VAC	1.5 KW 120 VAC TUNGSTEN
3 HP 277 VAC	4.8 KW 240 VAC TUNGSTEN
20 FLA/120 LRA, 120 VAC	20A, 277 VAC BALLAST
17 FLA/102 LRA, 277 VAC	

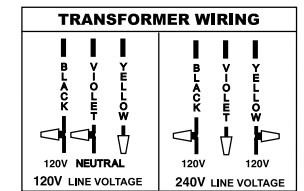

SUITABLE CIRCUIT BREAKERS	
SIEMENS	QP, QT, QPF, QE, QAF
MURRAY	MP-T, MH-T, MP-GT, MP-ET, MP-AT
TOTAL CONNECTED LOAD OF QT OR MH-T BREAKERS ON ONE BRANCH BUS SHALL NOT EXCEED 110A.	

Glossary

Control Panel: The EasyTouch control panel with flexible hinge. Installed in upper portion of EasyTouch load center to control the EasyTouch pool and spa system.

EMI (Electromagnetic interference) filter: Protective circuit element that must be used between the IntelliChlor transformer and supply lines.

High Voltage Panel/Compartment: Removable panel for the high voltage compartment of EasyTouch load center. The high voltage wiring including circuit breakers, relays, GFCI and optional IntelliChlor transformer/filter.

Indoor Control Panel: This 9 or 13 button remote controller with LCD (liquid crystal display) is wired to the motherboard in the EasyTouch load center. The control panel can be wall mounted inside a house to control the EasyTouch system.

IntelliChlor: Electronic salt chlorinator. Uses a process known as electrolysis to produce sodium hypochlorite (liquid chlorine) from a low concentration of salt added to the pool water. Model IC 20 Cell (P/N 520554) for pools up to 20,000 U.S. gallons (75 liters) and model IC 40 Cell (P/N 520555) for pools up to 40,000 U.S. gallons (151 liters).

iS4: Four function spa-side remote. Spa wall or deck mounted.

Load Center: Metal enclosure with power relays, transformer, and circuit breakers. Used for distributing power for controlling EasyTouch Systems. Also known as the “sub-panel.”

Low Voltage Compartment: Top compartment of EasyTouch load center for all low voltage wiring.

Low Voltage Raceway: Vertical space in the left side of EasyTouch load center for low voltage cabling.

Motherboard: The circuit board mounted behind the EasyTouch control panel.

Relay Circuits: The circuits that control the relays on the motherboard. Connectors on top edge of the circuit board.

Screw Terminal Connector: Removable connector that may attach to circuit board with multiple sockets (anywhere from 2 to 6) to receive wires from controllers and sensors; wires held by screw terminals; multiple wires of a small enough gauge (usually 22 AWG) may be coupled to a single socket of a terminal connector.

Salt Chlorine Generator (SCG): Automated pool chlorinator that sanitizes using salt water (see IntelliChlor).

Transceiver: Used by the EasyTouch wireless control panel. Circuit board with attached antenna that can send and receive radio frequency (wireless) transmissions.



P/N 520583 - Rev C